

Specifications

- **Open-loop stroke: 300 μm @ 150V (fixed-free)**
 - *Tolerance value: 240~360 μm
 - **Operating voltage: -20 V ~ +150 V**
 - **Stiffness in motion direction: 0.46 N/ μm**
 - **Resonance frequency(fixed-free): 1170 Hz**
 - *Tolerance value: 900 ~ 1440 Hz
 - **Blocked force: 138 N (*Tolerance value: 106~170N)**
 - **Capacitance: 12 μF**
 - **Dimension: 84x10x36.8 mm**
 - **Mechanical interface: 11-M2 tapped hole and 1-M5 tapped hole**
 - **Environment: 0 to 85°C with humidity less than 40%**
 - **Mass: 171 g**
- *All dimensions and specifications stated are nominal.

Option:

- Mechanical interface can be tailor with an addition option fees.

Geometry

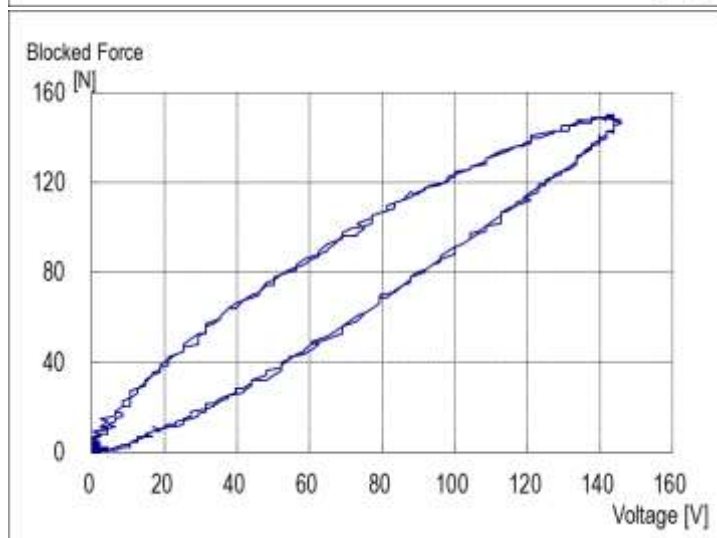
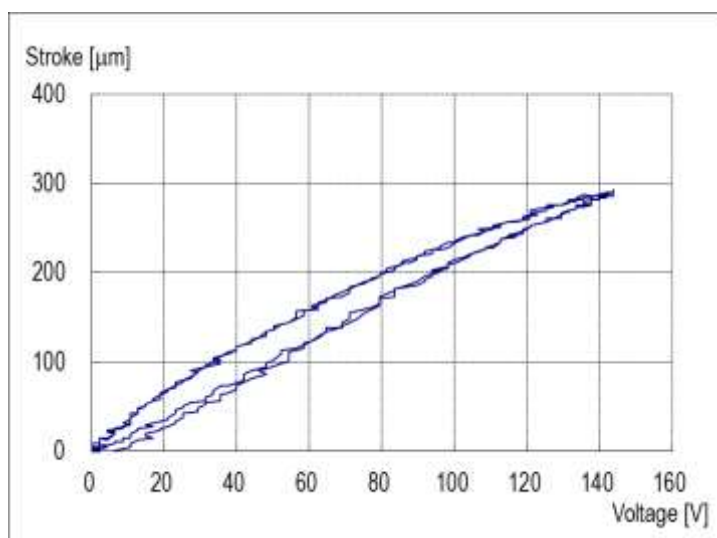
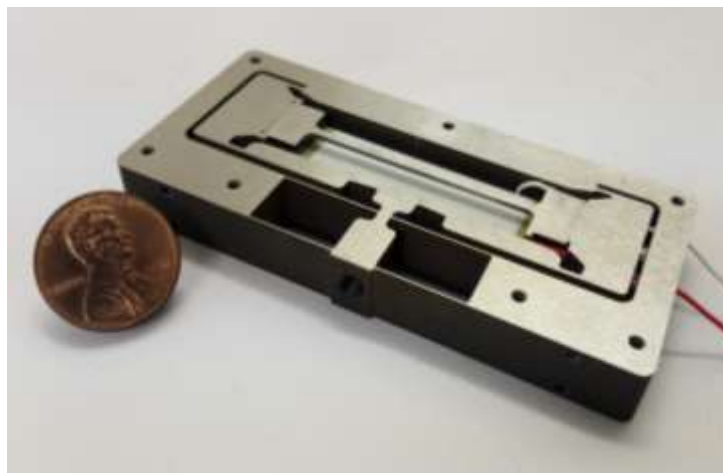
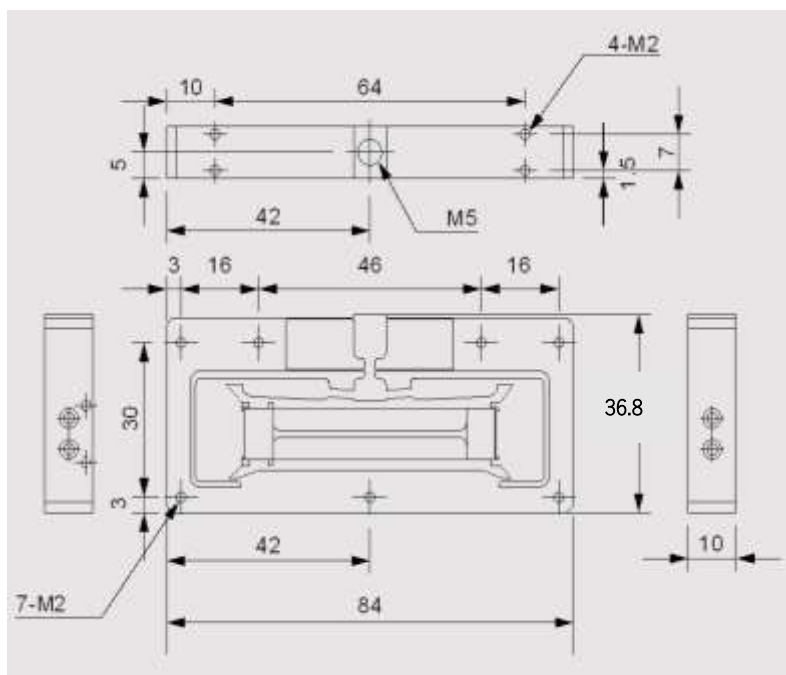

Note 1 : Actuation driven with MTAD4002 (without external load)

Setup

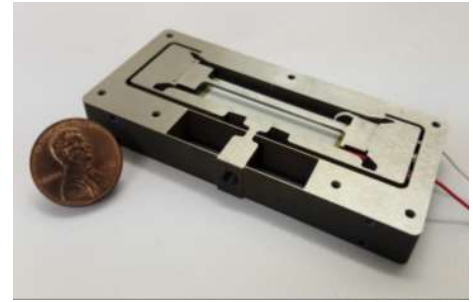
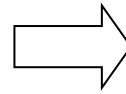
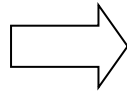
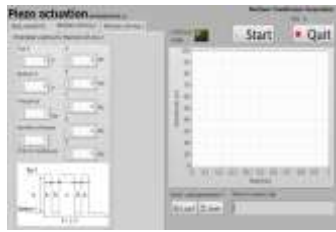

MT Actuation Software
(Attached with MTAD4002)

MTAD4002

MTKK10S300F120PS

Result

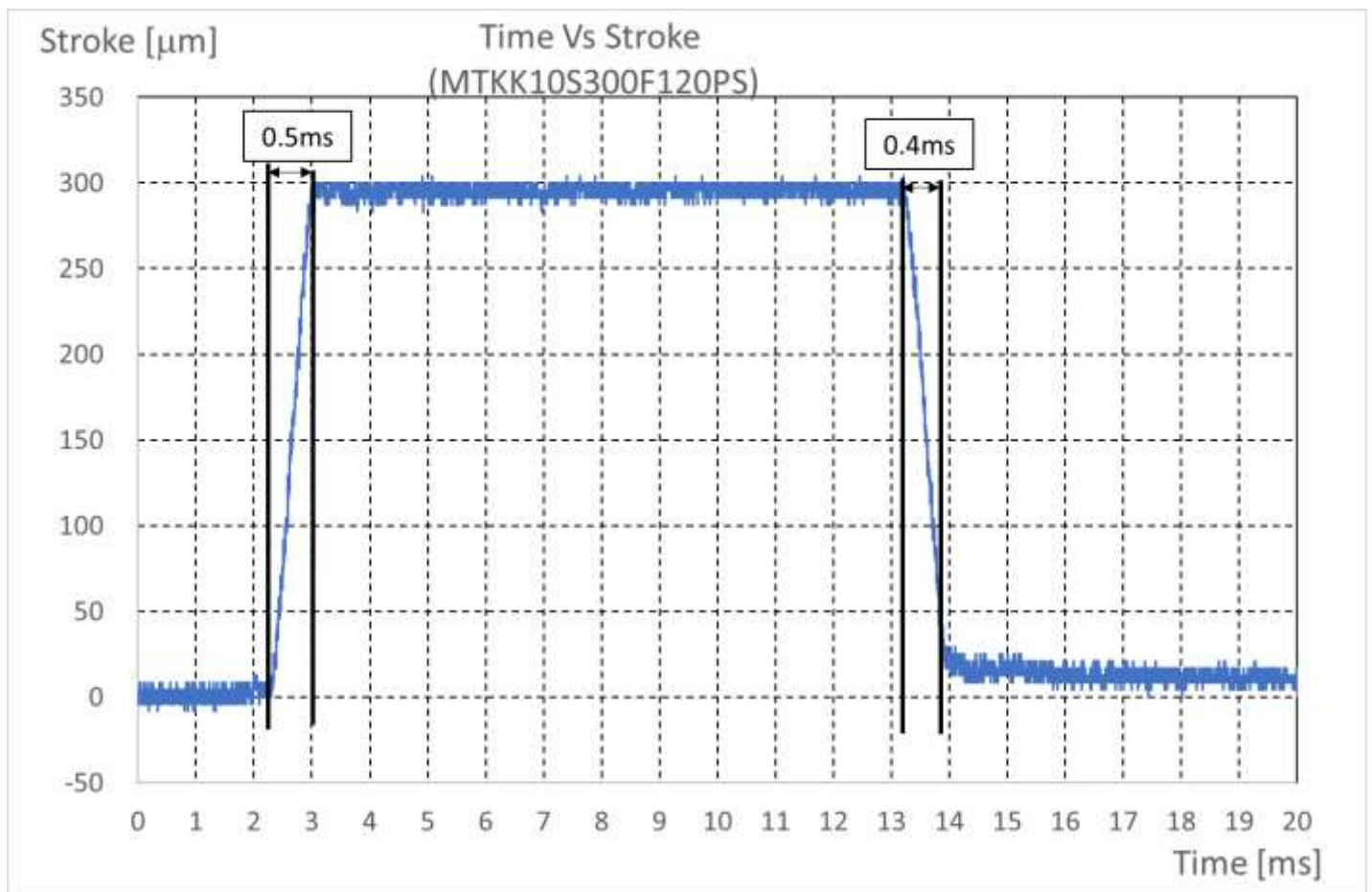

Conclusion

- Short rise time(0.5ms) and short falling time(0.4ms).
- Minimum residual vibration at the location of 300 μm .

Note 2 : Actuation driven with MTAD4002 (with external load 52g)

Setup

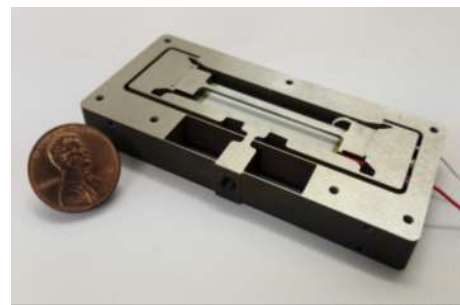
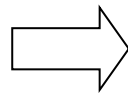
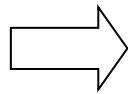

MT Actuation Software
(Attached with MTAD4002)

MTAD4002

MTKK10S300F120PS

Result

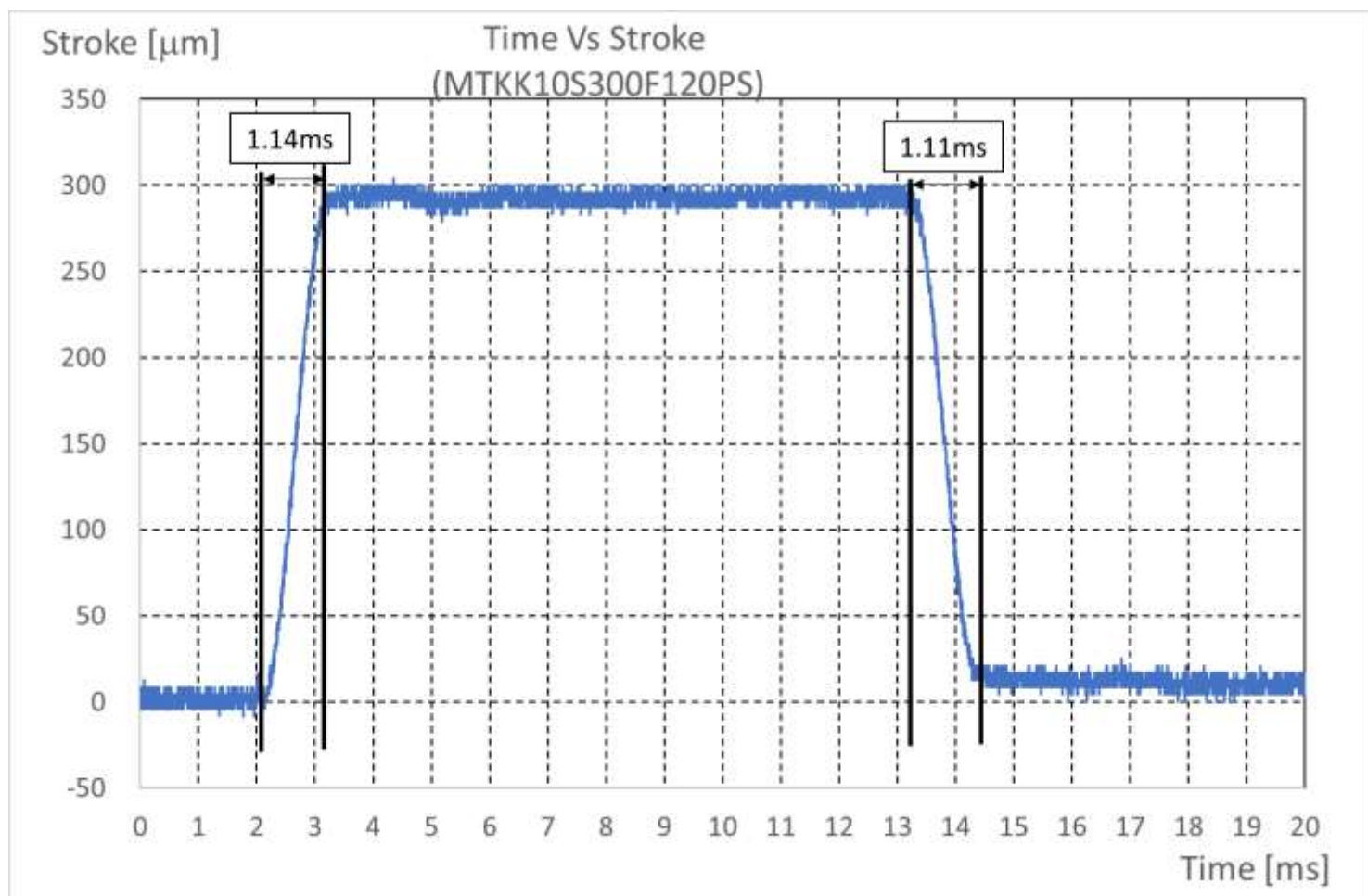

Conclusion

- Even with an external load of 52g, the rise time increase from 0.5ms to 1.14ms while the falling time increase from 0.4ms to 1.11ms.
- Minimum residual vibration at the location of 300 μm .

Note 3 : Comparison of Actuation driven (without load and external load 52g)

Setup

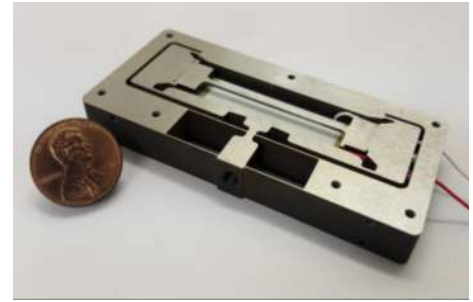
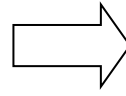
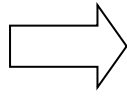
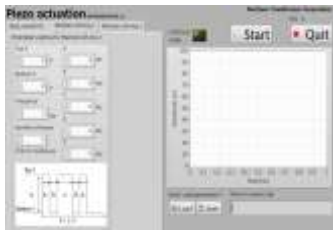

MT Actuation Software
(Attached with MTAD4002)

Result

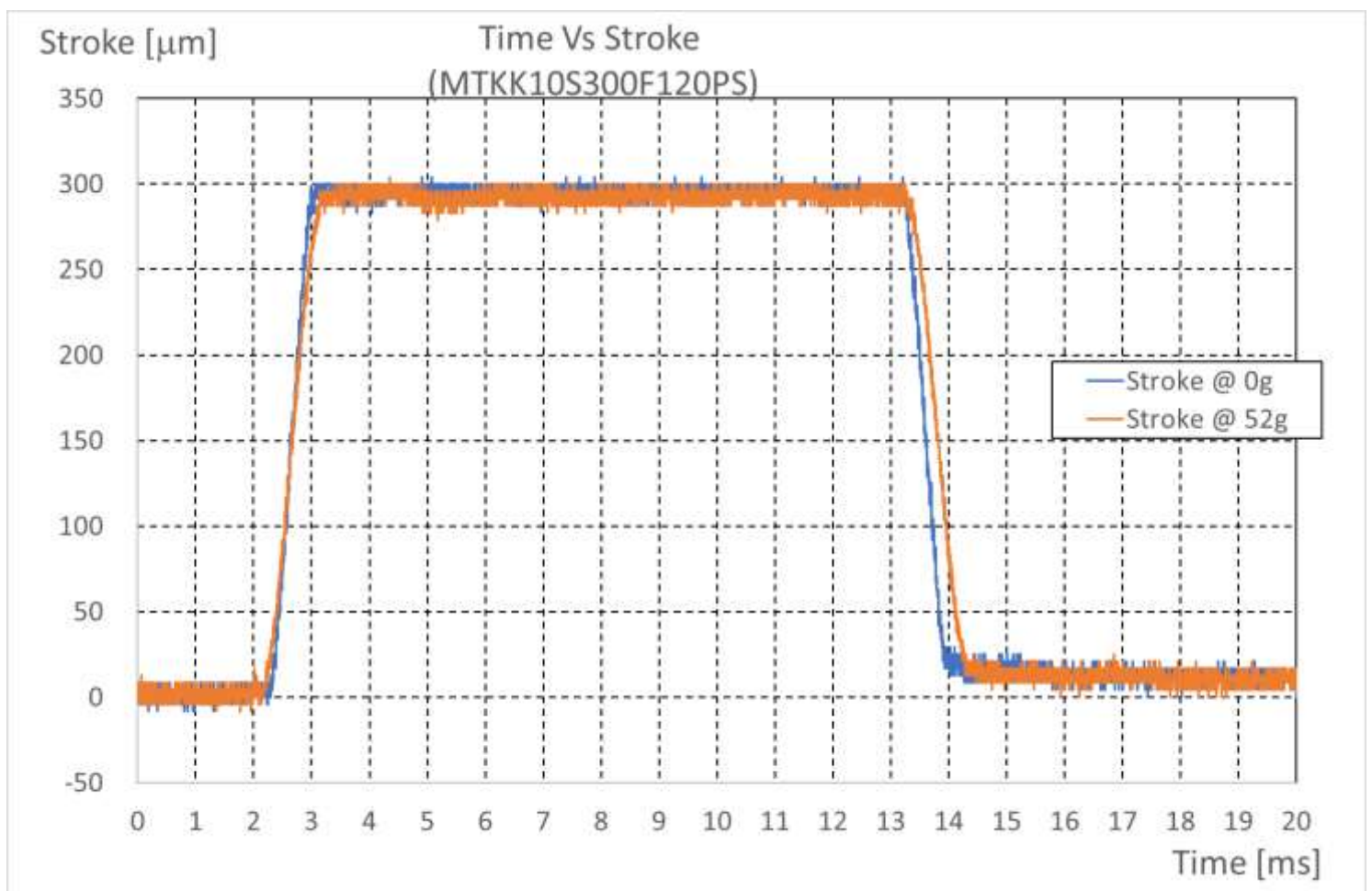

Conclusion

- The MTKK10S300F120PS can handle an external load to the distance of $300\mu\text{m}$ firmly and stably.

Note 4: Natural Resonant Frequency vs External Mass

The figure shows the relationship between the natural resonant frequency against the external mass. When there is no external mass added on MTKK10S300F120PS, the natural resonant frequency is measured as 1221Hz. However, when there is an external mass loaded on the MTKK10S300F120PS, the natural resonant frequency become lower as shown as figure below. Therefore, it is important to know the natural resonant frequency of your system when applying the MTKK10S300F120PS.

